

Keys and Sidebars

Benefits

- Two sets of key cuts designed to operate independent locking mechanisms
- Innovative key design protected by U.S. and international patents
- Patented key control offers the ultimate in high security
- Top cuts can be generated on standard, quality code cutting equipment
- ASSA's generous keying capabilities allow over 160,000 change keys under a single master key
- All ASSA keys are manufactured from the highest quality nickel silver material.

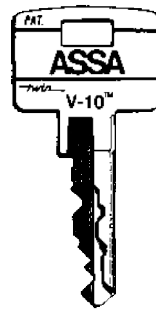

Twin V-10

Stocked sidebar codes

- 318 • 990
- 991 • 992
- 993 • 994
- 995 • A79
- A80 • B51
- B52 • B55
- B56

Applies to Registered Dealers Only.

- 250694 Twin V-10 Keyblanks/Sidebar code (specify sidebar code) Qty 100/box
- 267008 V-10, Twin 6000, & Twin Exclusive Sidebar (specify sidebar code) Qty 25/box

Pins & Springs

- 867066/807261 Driver Pin 1-2
- 867067/807262 Driver Pin 3-4
- 867068/807263 Driver Pin 5-6
- 867069/807264 Driver Pin 7-8-9
- 867070 Master Pin 1
- 867071 Master Pin 2
- 867072 Master Pin 3
- 867073 Master Pin 4
- 867074 Master Pin 5
- 867075 Master Pin 6
- 867076 Master Pin 7
- 867077 Master Pin 8
- 867078 Bottom Pin 1
- 867079 Bottom Pin 2
- 867080 Bottom Pin 3
- 867081 Bottom Pin 4
- 867082 Bottom Pin 5
- 867083 Bottom Pin 6
- 867084 Bottom Pin 7
- 867085 Bottom Pin 8
- 867086 Bottom Pin 9
- 807164 V-10/Twin Pro Sidebar Springs
- 867015 Twin Side Pins
- 867065 Cylinder Springs
- 867087 Twin Sidepin Springs
- 867088 Twin Sidebar Springs
- 353838 V-10 Left Hand Side Pins

Pin Kits



- MPK Master Pinning Kit Twin & IC
- PK-1 Pin Kit No.1 Full-Size Standard Kit for Twin
- PK-4 Pin Kit No.4 Mini Pin Kit for Twin

Lubricant

- 802631 ASSA Lock Spray Dry Film Lubricant

6000 Series Grade 1 Deadbolt Locks

Benefits:

- ASSA Hardhat™ to prevent physical attack
- Free spinning guard collars to prevent wrenching
- Available in interchangeable core
- High security solid brass cylinders
- 1/4" Aircraft strength steel mounting bolts
- Hardened bolt with full 1" throw
- Non-handed
- Patented key control

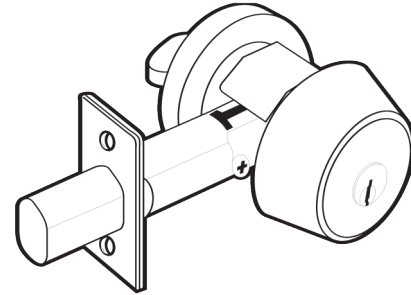

Certification:

- All ASSA 6000 Deadbolts are U.L. 437 Listed as well as ASTM F 1577 6.6 Certified for standard test methods for Detention Locks

Technical Information:

- Available in single and double cylinder and no thumb turn inside models
- Available in 2-3/8" and 2-3/4" backsets drive-in or face plate
- Available 1-3/8" to 2-1/2" door thickness, 1-3/4" standard
- Cylinder housing and plug made of high quality brass
- Stainless steel top pins
- Bottom pins and master pins are nickel silver

Twin 6000 Classic

- 6000-605-SNS Single cylinder w/thumbturn
- 6000-626-SNS Single cylinder w/thumbturn

Twin V-10

- V6000-605-SNS Single cylinder w/thumbturn
- V6000-626-SNS Single cylinder w/thumbturn

- 6000DC-605-SNS Double cylinder
- 6000DC-626-SNS Double cylinder

- V6000DC-605-SNS Double cylinder
- V6000DC-626-SNS Double cylinder

- 907001-605 2-3/4" Faceplate Bolt
- 907002-605 2-3/4" Drive-In Bolt
- 907003-626 2-3/8" Faceplate Bolt
- 907004-605 2-3/8" Drive-In Bolt

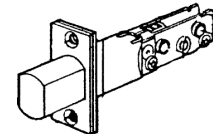

Padlocks

Benefits:

- Sturdy design ensures maximum durability
- Shackle made of rust proof stainless steel
- Drain holes to prevent freezing
- No external screws or rivets
- Patented key control

Technical Information:

- Class 2 body extruded brass, stainless steel shackle, tensile strength 1.5 tons
- Class 3 body case hardened steel, stainless steel shackle, tensile strength 4.5 tons
- Class 2 convertible from key retaining to non-key retaining
- Stainless steel top pins
- Bottom pins and master pins are nickel silver

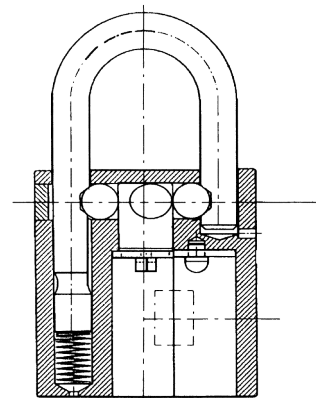

- 65191B No.2 Key-Retaining
- V65191B No.2 Key-Retaining
- V65391B No.3 Key-Retaining

Mortise and Rim Cylinders

Benefits:

- Drill resistant cylinder housing and plug
- Case-hardened steel inserts and stainless steel pins
- Two independent locking mechanisms to ensure optimum pick resistance
- Inactive “false” grooves on side pins designed to catch picking tools
- Extremely close tolerances
- Can be easily rekeyed in the field
- With the purchase of one inexpensive kit, 1-1/8” mortise cylinder is easily converted to rim cylinder
- Standard rim cylinder is easily converted to mortise cylinder
- All ASSA Twin Series Mortise cylinders are U.L. 437 listed as well as ASTM F 1577 6.6 listed for standard test methods for detention Locks.



Technical Information:

- Available in cylinder lengths 1-1/8” through 2” in 1/8’ increments
- Available with limited rotation and/or unidirectional features
- 13 cam options available
- Cylinder housing and plug are made of high quality brass
- Stainless steel top pins
- Bottom pins and master pins are nickel silver

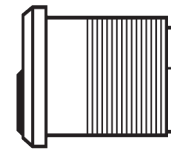

1-1/8” Mortise Cylinder , Twin 6000 Classic

- 6551-1-605-SNS with Adams Rite Cam
- 6551-1-626-SNS with Adams Rite Cam

1-1/8” Mortise Cylinder , Twin V-10

- V6551-1-605-SNS with Adams Rite Cam
- V6551-1-626-SNS with Adams Rite Cam
- V6551-2-605-SNS with Sargent Cam
- V6551-2-626-SNS with Sargent Cam
- V6551-5-605-SNS with Yale Standard Cam
- V6551-5-626-SNS with Yale Standard Cam
- V6551-6-605-SNS with Schlage “L” Cam
- V6551-6-626-SNS with Schlage “L” Cam

1-1/4” Mortise Cylinder , Twin V-10

- V6552-5-605-SNS with Yale Standard Cam
- V6552-5-626-SNS with Yale Standard Cam

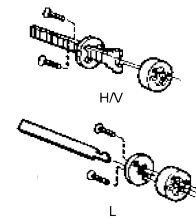
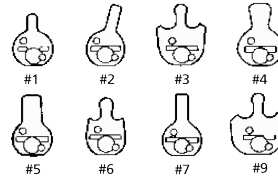

Cams, Tailpieces and Screws

- 867445 #1 Adams Rite Cam
- 867452 #2 Sargent Cam
- 867446 #3 Corbin Clover Leaf Cam
- 867447 #4 Corbin Beaver Tail Cam
- 872610 #5 Yale/Standard Cam
- 867453 #6 Schlage “L” Cam
- 805412 #7 Segal Type Cam
- 907306 #9 Best 30H Series
- 867450 Horizontal & Vertical Rim Tailpiece kit
- 867451 Lazy-motion Rim Tailpiece kit
- 868138 Slotted Screws for Rim Tailpiece
- 867090 Phillips Screws for Cams, Mortise

1-1/8” Rim Cylinder , Twin 6000 Classic

- 6551-H-605-SNS with Horizontal Tailpiece
- 6551-H-626-SNS with Horizontal Tailpiece

1-1/8” Rim Cylinder , Twin V-10

- V6551-H-605-SNS with Horizontal Tailpiece
- V6551-H-626-SNS with Horizontal Tailpiece

Key-in-Knob/Lever Cylinders

Benefits:

- Designed to exact manufacturers' specifications
- Two independent locking mechanisms to ensure security and optimum pick resistance
- Inactive "false" grooves on side pins designed to catch picking tools
- Extremely close tolerances
- Can be easily rekeyed in the field
- Patented key control

Certification:

- All ASSA Key-in-Knob/Lever cylinders are U.L. 437 listed

Technical Information:

- Available in 16 different retrofit assemblies
- Cylinder shell and plug made of high quality brass
- Stainless steel top pins
- Bottom pins and master pins are nickel silver

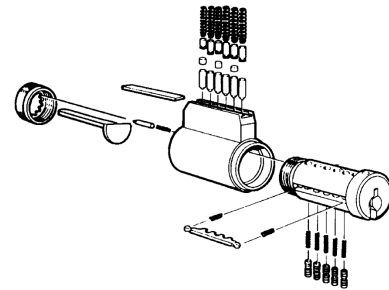

Twin V-10

- **V65611-605-SNS** Schlage Standard and heavy-duty 6-pin, includes cap, pin, spring and break-off tail-piece. For B series Deadbolts
- **V65611-626-SNS** Schlage Standard and heavy-duty 6-pin, includes cap, pin, spring and break-off tail-piece. For B series Deadbolts
- **V65672-605-SNS** Sargent Heavy-duty 7, 8, 9 lines KIK
- **V65672-626-SNS** Sargent Heavy-duty 7, 8, 9 lines KIK
- **V65673-605-SNS** Sargent Standard duty 3 tailpieces included 6 Line KIK, 7 Line KIL, 10 Line KIL
- **V65673-626-SNS** Sargent Standard duty 3 tailpieces included 6 Line KIK, 7 Line KIL, 10 Line KIL
- **V65691-605-SNS** Standard and heavy-duty, 3 tailpiece included for Arrow C, H, L, M, Q, S & W Series Key-in-Knob & Key-in-Lever styles
- **V65691-626-SNS** Standard and heavy-duty, 3 tailpiece included for Arrow C, H, L, M, Q, S & W Series Key-in-Knob & Key-in-Lever styles
- **V65692-605-SNS** For Arrow deadbolts only, includes tailpieces for double & single cylinders
- **V65692-626-SNS** For Arrow deadbolts only, includes tailpieces for double & single cylinders

Twin 6000 Classic

- **65611-605-SNS** Schlage Standard and heavy-duty 6-pin, includes cap, pin, spring and break-off tailpiece. For B series Deadbolts
- **65611-626-SNS** Schlage Standard and heavy-duty 6-pin, includes cap, pin, spring and break-off tailpiece. For B series Deadbolts
- **65691-605-SNS** Standard and heavy-duty, 3 tailpiece included for Arrow C, H, L, M, Q, S & W Series Key-in-Knob & Key-in-Lever styles
- **65691-626-SNS** Standard and heavy-duty, 3 tailpiece included for Arrow C, H, L, M, Q, S & W